

## Oxetanes as versatile building blocks in the total synthesis of natural products: An overview

Ahmed Mahal \*

Department of Chemistry of the Natural Products, School of Pharmacy, University of Naples Federico II, Via D. Montesano 49, 80131 Napoli, Italy

\* Corresponding author at: Department of Chemistry of the Natural Products, School of Pharmacy, University of Naples Federico II, Via D. Montesano 49, 80131 Napoli, Italy.

Tel.: +39.081.678550. Fax: +39.081.678532. E-mail address: [ahmed.salem@unina.it](mailto:ahmed.salem@unina.it) (A. Mahal).

### REVIEW INFORMATION



DOI: 10.5155/eurjchem.6.3.357-366.1267

Received: 27 April 2015

Accepted: 01 June 2015

Published online: 30 September 2015

Printed: 30 September 2015

### KEYWORDS

Oxetane  
 Anti-tumor  
 Drug discovery  
 Small molecules  
 Natural products  
 Heterocyclic synthesis

### ABSTRACT

Oxetane ring plays an important role as main core in naturally occurring compounds and has many applications in pharmaceutical industries and synthetic organic chemistry. In this review, we report a brief survey of using the oxetane ring as versatile precursors in the total synthesis of natural products. Many approaches such as cyclization, addition, oxidation, reduction, elimination, protection as well as deprotection reactions utilized to synthesize of most important oxetane-containing natural products involving taxol, (±)-merrilactone A, (±)-oxetin, L-oxetanocin, (+)-(-)-Z-laureatin and L-oxetanocin are also covered. We describe in this review the most common total synthesis approaches have been yet applied to synthesis of most important oxetane-containing natural products. The review is also included isolation, structure identification of these oxetane-containing natural products. The biological activity of oxetane-containing natural products due to the oxetane ring is also defined.

Cite this: *Eur. J. Chem.* 2015, 6(3), 357-366

### 1. Introduction

One of most important example as anti-tumor drug is Paclitaxel (Taxol) in which has the oxetane four-membered D-ring can be essential for biological activity of Paclitaxel (Taxol) [1]. Oxetane ring has also found in many other natural products such as oxetin, oxetanocin, and many other examples of oxetane containing natural products (Figure 1) [2,3].

Thromboxane A2 is a compound belonging to Thromboxane type which is obtained by activated platelets. Half-life of Thromboxane A2 is very short about 30 seconds in Plasma [3]. Mitrephorone A is a diterpenoids having an oxetane ring with ketone moieties was isolated in 2005 from *Mitrephora Glabra Scheff* by Oberlies and his co-workers and shown an activity as anticancers [4]. Maoyecrystal I is a diterpenoids was isolated from *Isidon japonicus* and the structure was confirmed by using spectroscopic methods. Sun and his co-workers reported that the cytotoxicity against K562 cells could be due to oxetane ring existed in the structure of Maoyecrystal I [5]. Dictyoxetane is a diterpenoid was first isolated in 1985 by Clardy and his co-workers from brown algae *Dictyoatadichotoma* in Indian Ocean. Unusual structure of Dictyoxetane has attracted much attention to be synthesized [6-10]. Bradyoxetin is a symmetrical bis-oxetane ring has shown to be

signaling molecule for *Bradyrhizobium japonicum* involved in symbiotic gene regulation [11]. We aim in this study to shed light on the oxetane as useful building blocks for the synthesis of some important biologically active oxetane-containing natural products.

### 2. Oxetane as building blocks for synthesis of L-oxetanocin

The first isolation of Oxetanocin was in 1986 from the soil-bacterium *Bacillus megaterium* NK84-0218 [12]. Oxetanocin has shown an activity to inhibit the HIV-virus that causes the AIDS disease [13]. Many approaches have described the total synthesis of Oxetanocin [14-19]. Oxetanocin has attracting much attention due to its high biological activity. Chu and his co-workers have achieved the total synthesis of L-Oxetanocin (Scheme 1) in 16 steps and 2.8% overall yield [20] avoiding the use of Lewis acid since they used coupling reaction between the oxetane ring and nucleobase.

Starting from protected L-xylose was converted in 8 steps to protected derivative 2 [20,21]. Deprotection of derivative 2 to lactol 3 followed by oxidation of compound 3 to lactone 4. In order to get a convenient yield, this step was completed using amended procedure [22] upon control of pH to be between 4.5-4.8.

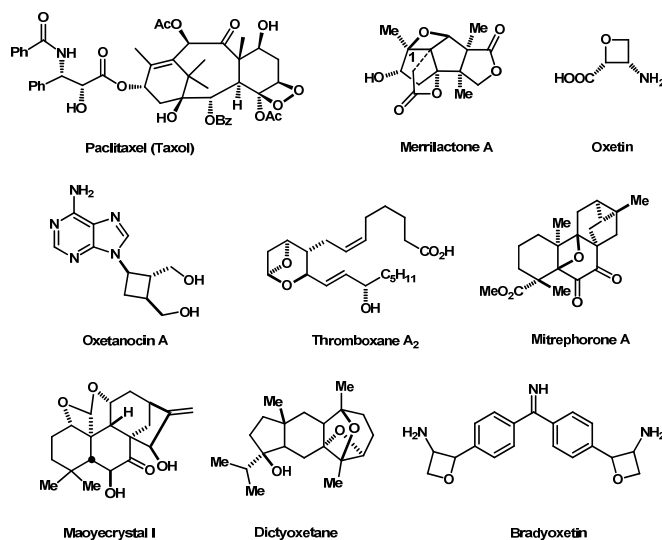
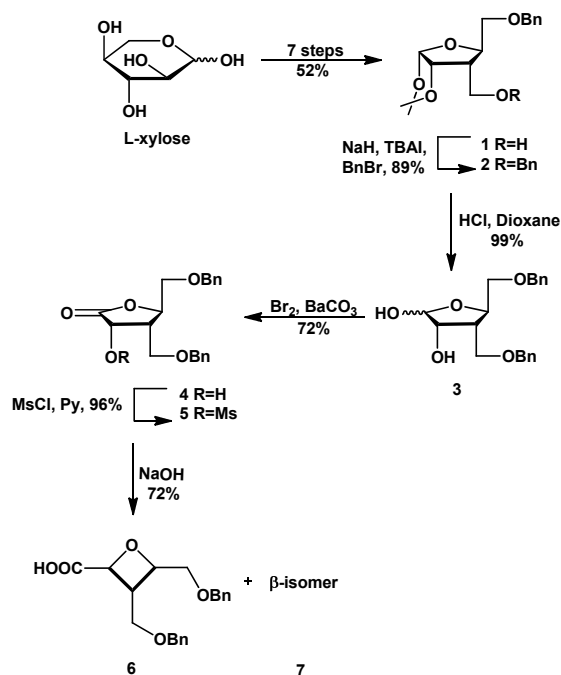

Figure 1. Oxetane-containing natural products.



Scheme 1

Mesylation of lactone **4** to compound **5** followed by ring contraction to yield acids **6** and **7** (3:1) (73%) [20,23].

The acids **6** and **7** underwent one-pot reaction to afford epimeric thiopyridyl oxetanes **8** in 30% yield. The coupling reaction of compound **8** was resulted the protected derivatives **9** and **10** (2:3) in 61% yield. Removing of benzyl protected group yielded compounds **11** and **12** and then hydrogenation reaction was achieved using palladium black to result Oxetanocin and its  $\alpha$ -isomer **13** in 90% yield (Scheme 2).

### 3. Oxetane as building blocks for synthesis of ( $\pm$ )-oxetin

Oxetin is an amino acid antimetabolite was isolated in 1984 from the fermentation broth of a *Streptomyces* sp. OM-

2317 with herbicidal and antibacterial activity [24,25]. It has (2*R*,3*S*) configuration as was confirmed by X-ray crystallography. Total synthesis of Oxetin has accomplished by many groups [25,26]. Bach and his co-workers have showed an efficient method to synthesis of Oxetin (*Rac*-1) in four steps with an overall yield 14% [27]. They have been started from available *n*-butyl glyoxylate **14** [28] underwent a stereoselective Paternò-Büchi reaction with 2 equivalent of available enecarbamate [29] to afford diastereomerically pure oxetane **15** in yields of 28-35% (Scheme 3).

Catalytic hydrogenolysis was used to remove the *N*-benzyl group which led to yield the *n*-butyl ester **16** (50%) and its methyl derivative **17** (17%).

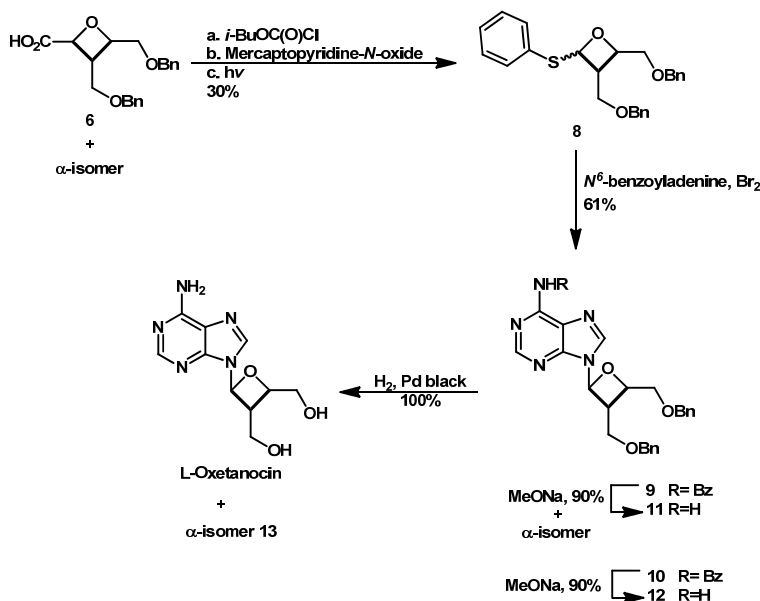

Scheme 2

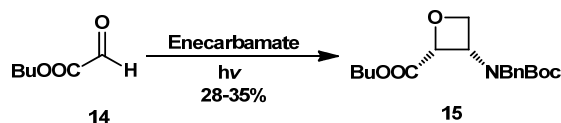

Scheme 3

Oxetin was obtained in a good yield by removal of protected amine of compound **16** followed by saponification of compound **18** as shown in [Scheme 4](#).

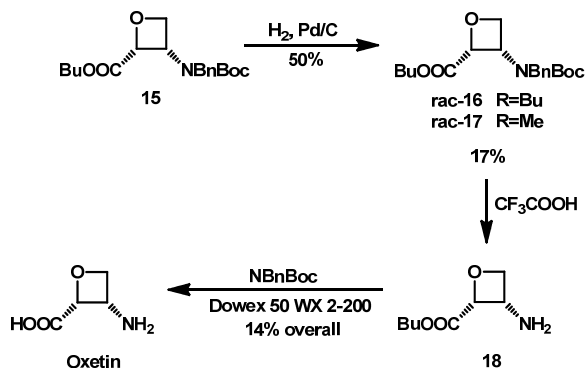

Scheme 4

#### 4. Oxetane as building blocks for synthesis of (±)-merrillactone A

Merrillactone A was isolated from *Illicium merrillianum* in 2000 by Fukuyama and co-workers and has shown an intriguing neurotrophic activity in the cultures of fetal rat cortical neurons [30]. The crystal structure of Merrillactone A has identified to be a sesquiterpene possessing two  $\gamma$ -lactones as well as an oxetane ring. Due to the biological activity of Merrillactone A, many synthetic methodologies have applied to the total synthesis of Merrillactone A [31-36], among of these was total synthesis of (±)-Merrillactone A by Inoue and his co-

workers in 2003 based on ring reducing of meso-diketone [32]. Unnatural enantiomer of Merrillactone A has synthesized by Inoue and his co-workers in 2006 [37]. Fukuyama and his co-workers have reported a new approach to synthesis of core skeletons of Merrillactone A [38-40]. They were aimed to construct the core of meso-diketone therefore, they have started from [2+2] photocycloaddition between compound **19** and compound **20** which afforded the compound **21** [41,42]. Compound **21** was reducing to form double bond and followed by LAH-reduction of the anhydride yielded meso-diol, **22**. Converting two hydroxyl groups into benzyl ethers and then dihydroxylation has achieved to afford compound **23**. A one-pot reaction [43] of Swern oxidation/allylation (compound **23**, **24** and **25**) afforded compound **25 $\alpha$**  as the major isomer since *cis*-introduction of allyl groups occurred from  $\alpha$ -face, this step has accomplished in one step to avoid the hydrolysis of diketone in aqueous workup. Ring-closing metathesis reaction [44-47] of compound **25** yielded bicyclo[4.2.0]octyl system **26**, then the reaction underwent upon treating with  $\text{Pb}(\text{OAc})_4$  in situ [48] to afford eight membered ring **27** (Scheme 5). The target compound **28** was selectively obtained from the reaction of compound **27** with  $\text{LiN}(\text{TMS})_2$  in THF at  $-100^\circ\text{C}$  (Scheme 6). Furthermore, they have optimized reaction conditions in order to get the best ratio of the target compound (Table 1).

**Table 1.** Reaction conditions of target compound **28**.

Entry	Reagents and conditions	Ratio <b>28</b>	Ratio <b>29</b>	Combined yield, %
1	$\text{LiN}(\text{TMS})_2$ , THF, $-110^\circ\text{C}$	3.1	1.0	85
2	$\text{LiN}(\text{TMS})_2$ , THF, $-40^\circ\text{C}$	2.6	1.0	78
3	$\text{MgBrN}(\text{TMS})_2$ , $\text{Et}_2\text{O}$ , RT	1.0	3.0	81
4	$\text{LiN}(\text{TMS})_2$ , $\text{Et}_3\text{N}$ , toluene, $-78^\circ\text{C}$	1.0	5.1	79
5	DBU, $\text{CH}_2\text{Cl}_2$ , $0^\circ\text{C}$	1.1	1.0	63

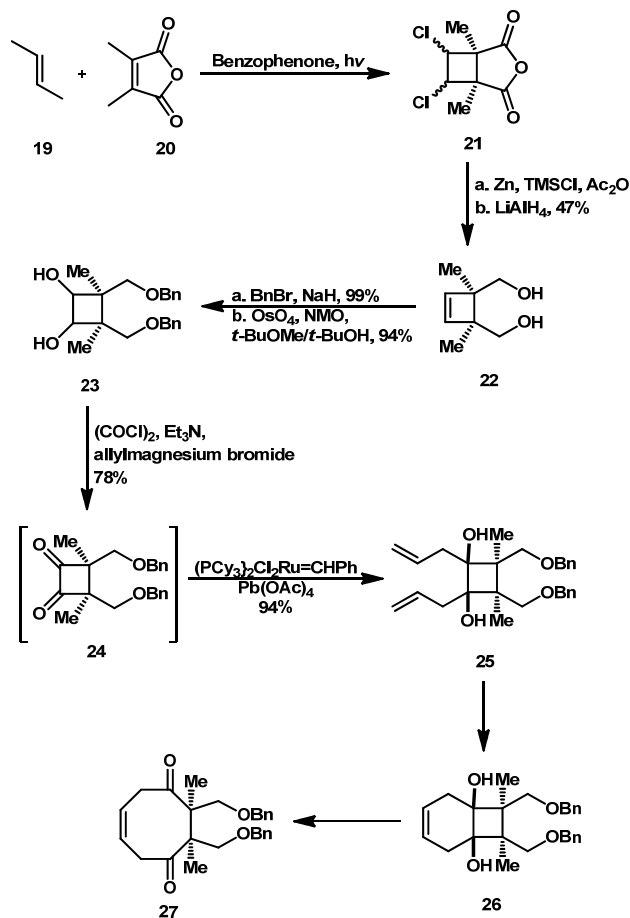

Scheme 5

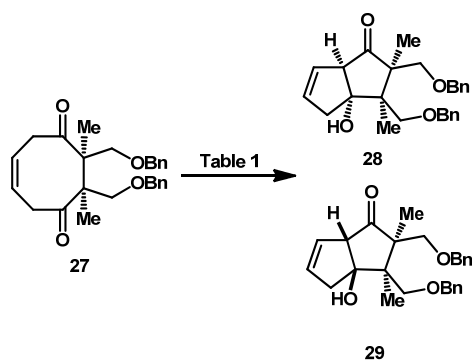

Scheme 6

$\alpha$ -Epoxide **30** was produced as a result of epoxidation reaction of compound **28** which converted to compound **31** through 2 steps involving epoxide ring opening with DBU and then IBX oxidation [49,50].  $\alpha$ -bromoacetal was added to compound **31** to yield compound **32** as a 4:1 mixture of diastereomers (Scheme 7).

Radical cyclization using  $\text{Bu}_3\text{SnH}$  and  $\text{BET}_3$  [51,52] produced a highly yield of 5-exo cyclized product **33** [53-55] although the steric effect around C9. They have transformed **33 $\alpha$**  into **33 $\beta$**  using acidic ethanol. The compound **34** which has all of the carbons of **1** in place was synthesized by the regioselective silyl enol formation from **33 $\beta$**  and then reacted

with Eschenmoser reagent followed by *m*-CPBA [56]. Two steps was used in order to prepare enol ether **35**, first upon treatment with TFA/ $\text{H}_2\text{O}$  and the second step using mesylation and base induced elimination as shown in Scheme 8.

L-Selectride was used to reduce enone **35** followed by an in situ triflation of the resultant enolate [57,58] which resulted compound **36**. Reduction of compound **36** by using palladium afforded olefin **37** [59]. The isomer benzyl ethers **38** was generated by reduction reaction using DIBAL at  $-78^\circ\text{C}$ . The tetraol **40** was obtained by birch reduction of benzyl ethers **38** afforded triol **39** in which was hydrated (Scheme 9).

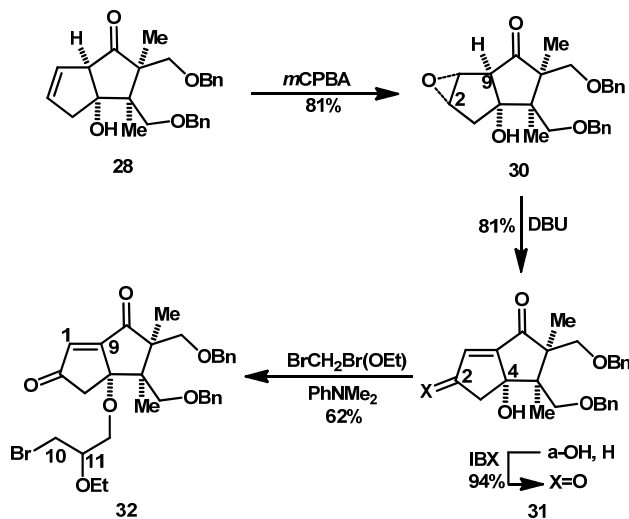

Scheme 7

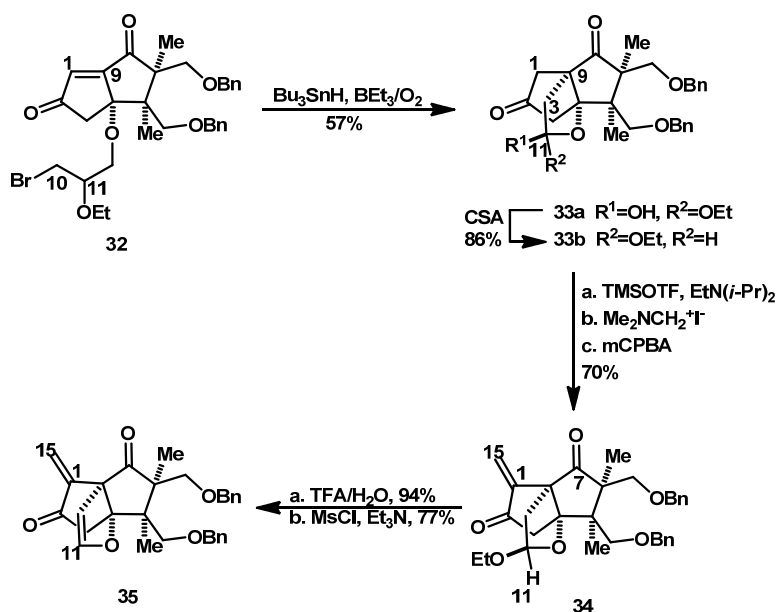

Scheme 8

They were regio- and chemo-selectivities oxidized C11 and C12 alcohol by Fetizon oxidation [60,61] afforded *bis*-lactone 41. Epoxidation of *bis*-lactone 41 using dimethyldioxirane [62,63] yielded compound 42, then treatment with acidic condition afforded the natural product of ( $\pm$ )-merrilactone A via epoxide-opening oxetane formation (Scheme 10) [30,31].

### 5. Oxetane as building blocks for synthesis of (+)-(*Z*)-laureatin

Laureatin is a metabolite of the red algae was first isolated from *Laurencia nipponica* Yamada in 1968 by Irie and his co-workers with larvicidal activity in a mosquitos [64,65]. Three approaches have been described the total synthesis of Laureatin [66-68]. Suzuki and his co-workers were reported the first total synthesis of Laureatin based on biosynthesis pathway which was proposed by Murai's group [69-71] as shown in Scheme 11.

They have attempted to prepare laureatin starting from  $\alpha,\alpha$ -trans-oxocene core 43, the first attempt was failed to convert oxocene 6 to bicyclic skeletons and instead of that, tetrahydrofuran derivative was produced. The second trial was used cyclization of hydroxyl epoxide. The compound 44 was obtained by protection of hydroxyl group of oxocene 43, followed by removal of benzyl protecting group of compound 44 afforded compound 45. Epoxidation of compound 45 was preceded through  $\beta$ -selectivity to yield compound 46 up to 96%. Upon treatment of compound 46 with aqueous KOH in DMSO [72] led to regioselective 4-*exo* cyclization which resulted laureatin bicyclic system 47. The compound 47 was then protected using pivaloyl chloride to afford compound 48 as shown in Scheme 12.

The complete conversion of compound 49 was obtained by mesylation of compound 48 and then using of CsOAc and 18-crown-6 in toluene [73].

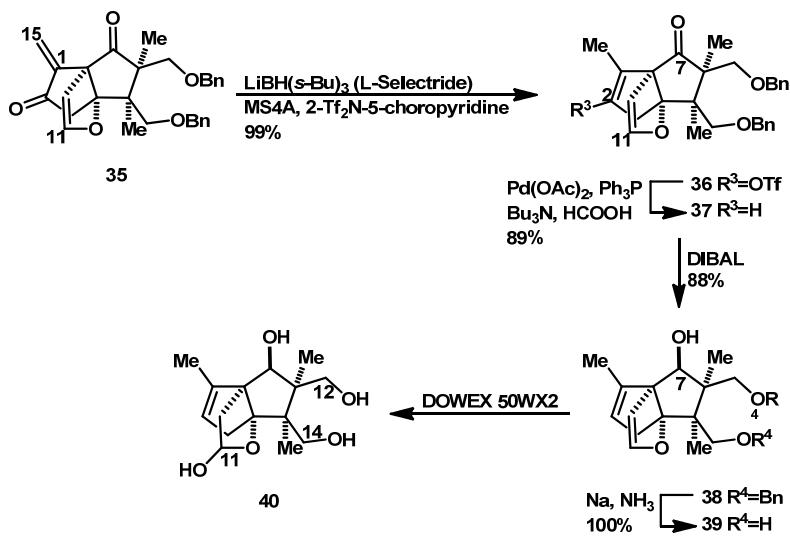

Scheme 9

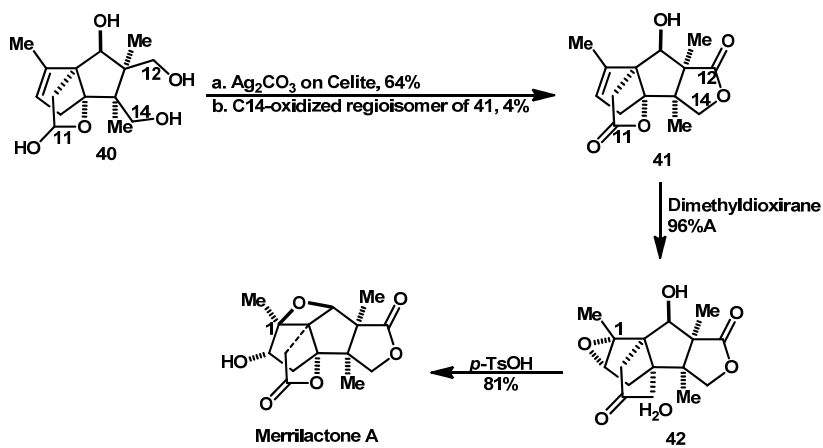

Scheme 10

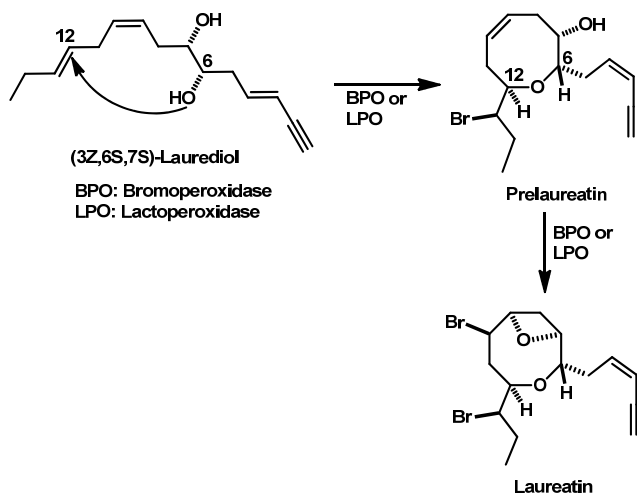

Scheme 11

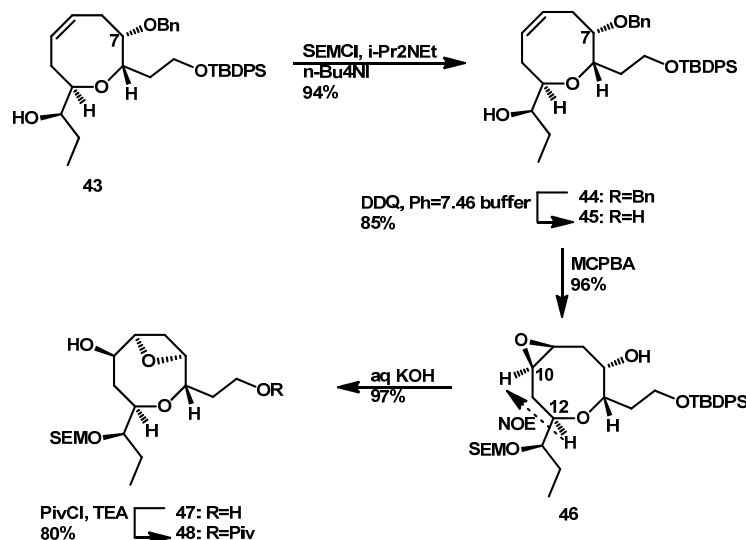

Scheme 12

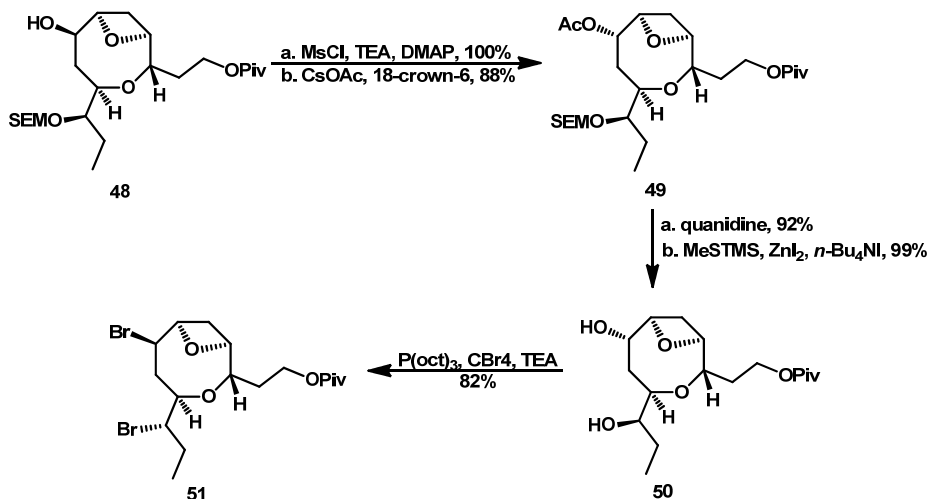

Scheme 13

Removal of protecting groups of the acetyl and SEM led to form two hydroxyl groups **50** which subjected to bromination reaction via  $\text{S}_\text{N}^2$  using Murai's procedure [74] to yield dibromide **51** (Scheme 13).

After reduction of pivaloyl group in compound **51** to hydroxyl group in 96% yield, the C-C bond forming proceeded as the following steps [75]: Oxidation using Dess-Martin peridinate (93%), then reacted with  $\text{CBr}_4$  and HMPT in THF (93%) [76] and stereoselective hydrogenolysis of 1,1-dibromoalkene by Uenishi's approach (82%) [77], followed by sonogashira coupling of the Z-1-bromoalkene (90%) [78]. TBS group in compound **52** was removed to afford final target of (+)-(Z)-laureatin (Scheme 14).

## 6. Oxetane as building blocks for synthesis of taxol

Taxol [79], is anticancer natural product drug was first isolated from the cytotoxic methanolic extract of the bark of *T. brevifolia* [80]. It has shown a very good activity as clinical agent [81,82] for the treatment of breast [83], ovarian [84-87], skin [88,89], lung [90-92], and head and neck [93] cancers.

Taxol was approved in 1993 by FDA for treatment of breast and ovarian cancers [94]. To date, seven methods was used in description the total synthesis of taxol [94-103]. Nicolaou and his co-workers were reported total synthesis of taxol and in 1994 [104-107]. They were described the construction of oxetane ring which was more challenging in the total synthesis of taxol in two pathways based on a taxoid skeleton achieved by Potier's group [108] and on a C ring model system performed by Danishefsky's group [109].

Danishefsky's approach [109] was started from intermediate **55** which was obtained either by silylation of compound **54** with TMSCl-pyridine or from degradation of 10-deacetylbaaccatin III [104]. Selectively removal of acetate group at C-20 was by using  $\text{K}_2\text{CO}_3$  in MeOH to yield triol **56**. The new hydroxyl group of triol **56** was selectively protected with TMSCl afforded compound **57** which was subjected to the triflation produced triflate silyl ether **58**. Oxetane ring **59** was obtained upon treatment with (silica gel,  $\text{CH}_2\text{Cl}_2$ ) accompanied by desilylation of C20-hydroxyl group followed by internal  $\text{S}_\text{N}^2$  displacement of the triflate as shown.

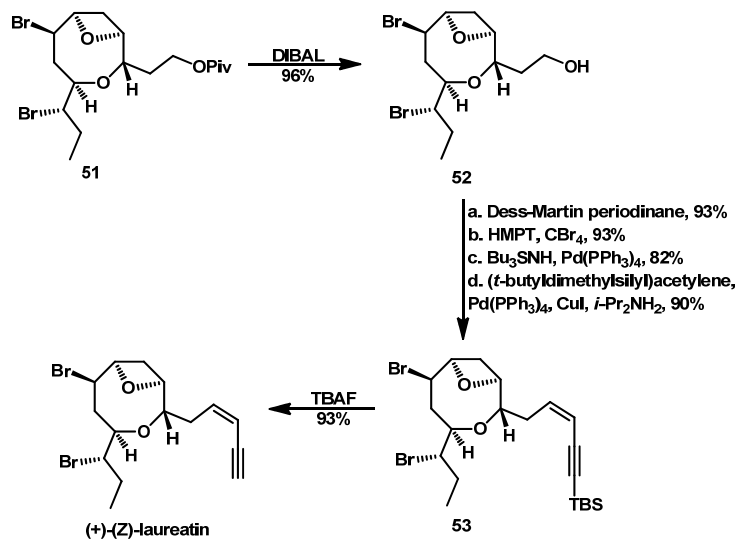

Scheme 14

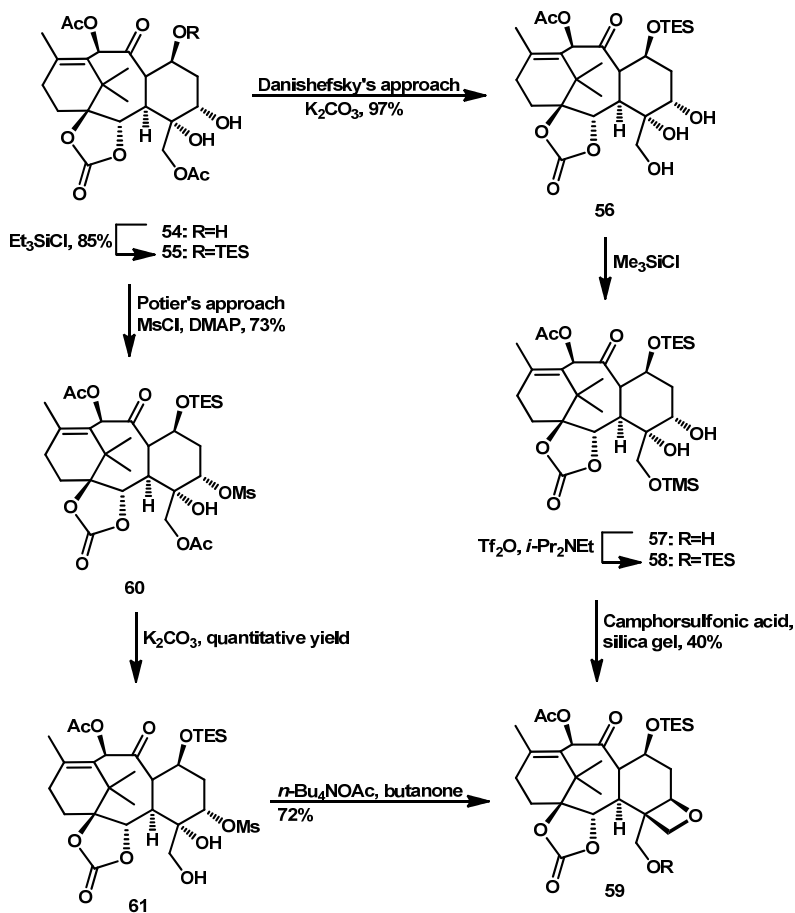

Scheme 15

Potier's approach was involved the same diol **55** which was converted into hydroxyl mesylate **60** followed by selective deacetylated at position 20 to afford diol **61**. The diol **61** was allowed to heating in refluxing butanone afforded oxetane ring **59** (Scheme 15).

#### 4. Conclusion

Due to the importance of oxetane ring as precursor for biologically active compounds and increasing use in drug industry as well as organic synthesis, we have overviewed



some synthetic pathways in order to construct core skeletons for important oxetane-containing natural products. We have studied the best useful approaches were used in the total synthesis of naturally occurring compounds.

### Acknowledgements

The author is gratefully acknowledged support from Università degli Studi di Napoli Federico II.

### References

- Wang, M.; Cornett, B.; Nettles, J.; Liotta, D. C.; Snyder, J. P. *J. Org. Chem.* **2000**, *65*, 1059-1068.
- Burkhard, J. A.; Wuitschik, G.; Rogers-Evans, M.; Müller, K.; Carreira, E. M. *Angew. Chem. Int. Ed.* **2010**, *49*, 9052-9067.
- Davis, O. A.; Bull, J. A. *Angew. Chem. Int. Ed.* **2014**, *53*, 14230-14234.
- Li, C.; Lee, D.; Graf, T. N.; Phifer, S. S.; Nakanishi, Y.; Burgess, J. P.; Riswan, S.; Setyowati, F. M.; Saribi, A. M.; Soejarto, D. D.; Farnsworth, N. R.; Falkinham III, J. O.; Kroll, D. J.; Kinghorn, A. D.; Wani, M. C.; Oberlies, N. H. *Org. Lett.* **2005**, *7*, 5709-5712.
- Han, Q. B.; Zhang, J. X.; Lu, Y.; Wu, Y. S.; Zheng, Q. T.; Sun, H. D. *Planta Med.* **2004**, *70*, 581-584.
- Pullaiah, K. C.; Surapaneni, R. K.; Rao, C. B.; Albizati, K. F.; Sullivan, B. W.; Faulkner, D. J.; He, C. H.; Clardy, J. *J. Org. Chem.* **1985**, *50*, 3665-3666.
- Reinecke, J.; Hoffmann, H. M. R. *Chem. Eur. J.* **1995**, *1*, 368-373.
- Marshall, K. A.; Mapp, A. K.; Heathcock, C. H. *J. Org. Chem.* **1996**, *61*, 9135-9145.
- Wittenberg, J.; Beil, W.; Hoffmann, H. M. R. *Tetrahedron Lett.* **1998**, *39*, 8259-8262.
- Proemmel, S.; Warchow, R.; Hoffmann, H. M. R. *Tetrahedron* **2002**, *58*, 6199-6206.
- Loh, L.; Carlson, R. W.; York, W. S.; Stacey, G. *Proc. Natl. Acad. Sci.* **2002**, *99*, 14446-14451.
- Shimada, N.; Hasegawa, S.; Harada, T.; Tomisawa, T.; Fujii, A.; Takita, T. *J. Antibiot.* **1986**, *39*, 1623-1625.
- Hoshino, H.; Shimizu, N.; Shimada, N.; Takita, T.; Takeuchi, T. *J. Antibiot.* **1987**, *40*, 1077-1078.
- Niitsuma, S.; Ichikawa, Y.; Kato, K.; Takita, T. *Tetrahedron Lett.* **1987**, *28*, 3967-3970.
- Niitsuma, S.; Ichikawa, Y.; Kato, K.; Takita, T. *Tetrahedron Lett.* **1987**, *28*, 4713-4714.
- Ichikawa, E.; Kato, K. *Synthesis* **2002**, *2002*, 1-28.
- Wilson, F. X.; Fleet, G. W. J.; Vogt, K.; Wang, Y.; Witty, D. R.; Choi, S.; Storer, R.; Myers, P. L.; Wallis, C. J. *Tetrahedron Lett.* **1990**, *31*, 6931-6934.
- Saksena, A. K.; Ganguly, A. K.; Girijavallabhan, V. M.; Pike, R. E.; Chen, Y.; Puar, M. S. *Tetrahedron Lett.* **1992**, *33*, 7721-7724.
- Norbeck, D. W.; Kramer, J. B. *J. Am. Chem. Soc.* **1988**, *110*, 7217-7218.
- Gumina, G.; Chu, C. K. *Org. Lett.* **2002**, *4*, 1147-1149.
- Czernecki, S.; Georgoulis, C.; Provelenghiou, C. *Tetrahedron Lett.* **1976**, *17*, 3535-3536.
- Pudlo, J. S.; Townsend, L. B. *Nucleic Acid Chemistry, Part 4*; Townsend, L. B.; Tipson, R. S. Eds.; Wiley: New York, 1978; pp. 1151.
- Saksena, A. K.; Ganguly, A. K.; Girijavallabhan, V. M.; Pike, R. E.; Chen, Y. T.; Puar, M. S. *Tetrahedron Lett.* **1992**, *33*, 7721-7724.
- Omura, S.; Murata, M.; Imamura, N.; Iwai, Y.; Tanaka, H.; Furusaki, A.; Matsumoto, T. *J. Antibiot.* **1984**, *37*, 1324-1332.
- Kawahata, Y.; Takatsuto, S.; Ikekawa, N.; Murata, M.; Omura, S. *Chem. Pharm. Bull.* **1986**, *34*, 3102-3110.
- Tomoda, H.; Omura, S. *J. Antibiot.* **1990**, *43*, 1207-1022.
- Bach, T.; Schröder, J. *Eur. J. Org. Chem.* **1997**, *11*, 2265-2267.
- Kelly, T. R.; Schmidt, T. E.; Haggerty, J. G. *Synthesis* **1972**, 544-545.
- Meth-Cohn, K. T.; Westwood, T. *J. Chem. Soc. Perkin Trans. 1* **1984**, 1173-1182.
- Huang, J. M.; Yokoyama, R.; Yang, C. S.; Fukuyama, Y. *Tetrahedron Lett.* **2000**, *41*, 6111-6114.
- Birman, V. B.; Danishefsky, S. J. *J. Am. Chem. Soc.* **2002**, *124*, 2080-2081.
- Inoue, M.; Sato, T.; Hiram, M. *J. Am. Chem. Soc.* **2003**, *125*, 10772-10773.
- Meng, Z.; Danishefsky, S. J. *Angew. Chem., Int. Ed.* **2005**, *44*, 1511-1513.
- Inoue, M.; Sato, T.; Hiram, M. *Angew., Chem. Int. Ed.* **2006**, *45*, 4843-4548.
- He, W.; Huang, J.; Sun, X.; Frontier, A. J. *J. Am. Chem. Soc.* **2008**, *130*, 300-308.
- Mehta, G.; Singh, S. R. *Angew. Chem.* **2006**, *118*, 967-969.
- Inoue, M.; Lee, N.; Kasuya, S.; Sato, T.; Hiram, M.; Moriyama, M.; Fukuyama, Y. *J. Org. Chem.* **2007**, *72*, 3065-3075.
- Harada, K.; Kato, H.; Fukuyama, Y. *Tetrahedron Lett.* **2005**, *46*, 7407-7410.
- Harada, K.; Ito, H.; Hioki, H.; Fukuyama, Y. *Tetrahedron Lett.* **2007**, *48*, 6105-6108.
- Iriondo-Alberdi, J.; Perea-Buceta, J. E.; Greaney, M. F. *Org. Lett.* **2005**, *7*, 3969-3971.
- Schenck, G. O.; Hartmann, W.; Steinmetz, R. *Chem. Ber.* **1963**, *96*, 498-508.
- Gauvry, N.; Comoy, C.; Lescop, C.; Huet, F. *Synthesis* **1999**, 574-576.
- Ireland, R. E.; Norbeck, D. W. *J. Org. Chem.* **1985**, *50*, 2198-2200.
- Fu, G. C.; Nguyen, S. T.; Grubbs, R. H. *J. Am. Chem. Soc.* **1993**, *115*, 9856-9857.
- Schwab, P.; Grubbs, R. H.; Ziller, J. W. *J. Am. Chem. Soc.* **1996**, *118*, 100-110.
- Fürstner, A. *Angew. Chem. Int. Ed.* **2000**, *39*, 3012-3043.
- Trnka, T. M.; Grubbs, R. H. *Acc. Chem. Res.* **2001**, *34*, 18-29.
- Balskus, E. P.; Mendez-Andino, J.; Arbit, R. M.; Paquette, L. A. *J. Org. Chem.* **2001**, *66*, 6695-6704.
- Frigerio, M.; Santagostino, M. *Tetrahedron Lett.* **1994**, *35*, 8019-8022.
- Frigerio, M.; Santagostino, M.; Sputore, S.; Palmisano, G. *J. Org. Chem.* **1995**, *60*, 7272-7276.
- Nozaki, K.; Oshima, K.; Utimoto, K. *J. Am. Chem. Soc.* **1987**, *109*, 2547-2549.
- Ollivier, C.; Renaud, P. *Chem. Rev.* **2001**, *101*, 3415-3434.
- Ueno, Y.; Chino, K.; Watanabe, M.; Moriya, O.; Okawara, M. *J. Am. Chem. Soc.* **1982**, *104*, 5564-5566.
- Stork, G.; Mook, R., Jr.; Biller, S. A.; Rychnovsky, S. D. *J. Am. Chem. Soc.* **1983**, *105*, 3741-3742.
- Zhang, W. *Tetrahedron* **2001**, *57*, 7237-7262.
- Danishefsky, S.; Kitahara, T.; McKee, R.; Schuda, P. F. *J. Am. Chem. Soc.* **1976**, *98*, 6715-6717.
- Crisp, G. T.; Scott, W. J. *Synthesis* **1985**, *1985*, 335-337.
- Comins, D. L.; Dehghani, A. *Tetrahedron Lett.* **1992**, *33*, 6299-6302.
- Cacchi, S.; Morera, E.; Ortari, G. *Tetrahedron Lett.* **1984**, *25*, 4821-4824.
- Fetizon, M.; Golfier, M. *Compt. Rend.* **1968**, *267*, 900-903.
- McKillop, A.; Young, D. W. *Synthesis* **1979**, 401-422.
- Murray, R. W. *Chem. Rev.* **1989**, *89*, 1187-1201.
- Adam, W.; Curci, R.; Edwards, J. O. *Acc. Chem. Res.* **1989**, *22*, 205-211.
- Irie, T.; Izawa, M.; Kurosawa, E. *Tetrahedron*, **1970**, *26*, 851-870.
- Irie, T.; Izawa, M.; Kurosawa, E. *Tetrahedron Lett.* **1968**, *9*, 2091-2096.
- Sugimoto, M.; Suzuki, T.; Hagiwara, H.; Hoshi, T. *Tetrahedron Lett.* **2007**, *48*, 1109-1112.
- Keshipedy, S.; Martinez, I.; Castillo II, F. B.; Morton, M. D.; Howell, R. A. *J. Org. Chem.* **2012**, *77*, 7883-7890.
- Kim, H.; Lee, H.; Lee, D.; Kim, S.; Kim, D. *J. Am. Chem. Soc.* **2007**, *129*, 2269-2274.
- Ishihara, J.; Shimada, Y.; Kanoh, N.; Takasugi, Y.; Fukuzawa, A.; Murai, A. *Tetrahedron* **1997**, *53*, 8371-8382.
- Ishihara, J.; Kanoh, N.; Murai, A. *Tetrahedron Lett.* **1995**, *36*, 737-740.
- Fukuzawa, A.; Aye, M.; Takasugi, Y.; Nakamura, M.; Tamura, M.; Murai, A. *Chem. Lett.* **1994**, 2307-2310.
- Murai, A.; Ono, M.; Masamune, T. *Bull. Chem. Soc. Jpn.* **1977**, *50*, 1226-1231.
- Torisawa, Y.; Okabe, H.; Ikegami, S. *Chem. Lett.* **1984**, *13*, 1555-1556.
- Tsushima, K.; Murai, A. *Tetrahedron Lett.* **1992**, *33*, 4345-4348.
- Fujiwara, K.; Akakura, D.; Tsunashima, M.; Nakamura, A.; Honma, T.; Murai, A. *J. Org. Chem.* **1999**, *64*, 2616-2617.
- Corey, E. J.; Fuchs, P. L. *Tetrahedron Lett.* **1972**, *13*, 3769-3772.
- Uenishi, J.; Kawahama, R.; Yonemitsu, O. *J. Org. Chem.* **1996**, *61*, 5716-5717.
- Sonogashira, K.; Tohda, Y.; Hagihara, N. *Tetrahedron Lett.* **1975**, *16*, 4465-4470.
- Nicolaou, K. C.; Dai, W. M.; Guy, R. K. *Angew. Chem., Int. Ed. Engl.* **1994**, *33*, 15-44.
- Wani, M. C.; Taylor, H. L.; Wall, M. E.; Coggen, P.; McPhail, A. T. *J. Am. Chem. Soc.* **1971**, *93*, 2325-2327.
- Lavelle, F. *Curr. Opin. Invest. Drugs* **1993**, *2*, 627-635.
- Rowinsky, E. K.; Onetto, N.; Canetta, R. M.; Arbuck, S. G. *Semin. Oncol.* **1992**, *19*, 646-662.
- Holmes, F. A.; Waters, R. J.; Theriault, R. I.; Forman, A. D.; Newton, L. K.; Raber, M. N.; Buzdar, A. U.; Frye, D. K.; Hortobagyi, G. N. *J. Natl. Cancer Inst. U.S.A.* **1991**, *83*, 1797-1805.
- McGuire, W. P.; Rowinsky, E. K.; Rosenshein, N. B.; Grumbine, F. C.; Ettinger, D. S.; Armstrong, D. K.; Donehower, R. C. *Ann. Intern. Med.* **1989**, *111*, 273-279.
- Einzig, A. I.; Wiemik, P. H.; Sasloff, J.; Garl, S.; Runowicz, C.; O'Hanlan, K. A.; Goldberg, G. *Proc. Am. Assoc. Cancer Res.* **1990**, *31*, 187-187.
- Pazdur, R.; Ho, D. H.; Lassere, Y.; Bready, B.; Kvakoff, I. H.; Raber, M. N. *Proc. Am. Soc. Clin. Oncol.* **1992**, *11*, 111-111.
- Caldas, C.; McGuire, W. P. *Semin. Oncol.* **1993**, *20* (4-3), 50-55.
- Einzig, A. I.; Hochster, H.; Wiemik, P. H.; Trump, D. L.; Dutcher, J. P.; Garowski, E.; Sasloff, J.; Smith, T. J. *Invest. New Drugs* **1991**, *9*, 59-64.
- Legha, S. S.; Ring, S.; Papadopoulos, N.; Raber, M. N.; Benjamin, R. *Cancer* **1990**, *65*, 2478-2481.
- Chang, A.; Kim, K.; Glick, J.; Anderson, T.; Karp, D.; Johnson, D. J. *Natl. Cancer Inst.* **1993**, *85*, 388-394.

- [91]. Murphey, W. K.; Winn, R. J.; Fossella, F. V.; Shin, D. M.; Hynes, H. E.; Gross, H. M.; Davila, E.; Leimert, J. T.; Dhinga, H. M.; Raber, M. N.; Krakoff, I. H.; Hong, W. K. *Proc. Am. Soc. Clin. Oncol.* **1993**, *85*, 384-388.
- [92]. Ettinger, D. S. *Semin. Oncol.* **1993**, *20* (4-3), 46-49.
- [93]. Forastiere, A. A. *Semin. Oncol.* **1993**, *20* (4-3), 56-60.
- [94]. Nicolaou, K. C.; Z. Yang, J. J. Liu, H. Ueno, P. G. Nantermet, R. K. Guy, C. F. Claiborne, J. Renaud, E. A. Couladouros, K. Paulvannan, E. J. Sorenson. *Nature*, **1994**, *367*, 630-634.
- [95]. Holton, R. H.; Somoza, C.; Kim, H. B.; Liang, F.; Biediger, R. J.; Boatman, P. D.; Shindo, M.; Smith, C. C.; Kim, S.; Nadizadeh, H.; Suzuki, Y.; Tao, Y.; Vu, P.; Tang, S.; Zhang, P.; Murthi, K. K.; Gentile, L. N.; Liu, J. H. *J. Am. Chem. Soc.* **1994**, *116*, 1597-1598.
- [96]. Holton, R. H.; Kim, H. B.; Somoza, C.; Liang, F.; Biediger, R. J.; Boatman, P. D.; Shindo, M.; Smith, C. C.; Kim, S.; Nadizadeh, H.; Suzuki, Y.; Tao, C.; Vu, P.; Tang, S.; Zhang, P.; Murthi, K. K.; Gentile, L. N.; Liu, J. H. *J. Am. Chem. Soc.* **1994**, *116*, 1599-1600.
- [97]. Danishefsky, S. J.; Masters, J. J.; Young, W. B.; Link, J. T.; Snyder, L. B.; Magee, T. V.; Jung, D. K.; Isaacs, R. C. A.; Bornmann, W. G.; Alaimo, C. A.; Coburn, C. A.; Di Grandi, M. G. *J. Am. Chem. Soc.* **1996**, *118*, 2843-2859.
- [98]. Wender, P. A.; Badham, N. F.; Conway, S. P.; Floreancig, P. E.; Glass, T. E.; Gränicher, C.; Houze, J. B.; Jänichen, J.; Lee, D.; Marquess, D. G.; McGrane, P. L.; Meng, W.; Mucciario, T. P.; Mühlebach, M.; Natchus, M. G.; Paulsen, H.; Rawlins, D. B.; Satkofsky, J.; Shuker, A. J.; Sutton, J. C.; Taylor, R. E.; Tomooka, K. *J. Am. Chem. Soc.* **1997**, *119*, 2755-2756.
- [99]. Wender, P. A.; Badham, N. F.; Conway, S. P.; Floreancig, P. E.; Glass, T. E.; Houze, J. B.; Krauss, N. E.; Lee, D.; Marquess, D. G.; McGrane, P. L.; Meng, W.; Natchus, M. G.; Shuker, A. J.; Sutton, J. C.; Taylor, R. E. *J. Am. Chem. Soc.* **1997**, *119*, 2757-2758.
- [100]. Morihira, K.; Hara, R.; Kawahara, S.; Nishimori, T.; Nakamura, N.; Kusama, H.; Kuwajima, I. *J. Am. Chem. Soc.* **1998**, *120*, 12980-12981.
- [101]. Morihira, K.; Hara, R.; Kawahara, S.; Nishimori, T.; Kashima, H.; Nakamura, N.; Morihira, K.; Kuwajima, I. *J. Am. Chem. Soc.* **2000**, *122*, 3811-3820.
- [102]. Shiina, I.; Iwadare, H.; Sakoh, H.; Hasegawa, M.; Tani, Y. I.; Mukaiyama, T. *Chem. Lett.* **1998**, *27*, 1-2.
- [103]. Doi, T.; Fuse, S.; Miyamoto, S.; Nakai, K.; Sasuga, D.; Takahashi, T.; *Chem. Asian J.* **2006**, *1*, 370-383.
- [104]. Nicolaou, K. C.; Nantermet, P. G.; Ueno, H.; Guy, R. K.; Couladouros, E. A.; Sorensen, E. J. *J. Am. Chem. Soc.* **1995**, *117*, 624-633.
- [105]. Nicolaou, K. C.; Liu, J. J.; Yang, Z.; Ueno, H.; Sorensen, E. J.; Claiborne, C. F.; Guy, R. K.; Hwang, C. K.; Nakada, M.; Nantermet, P. G. *J. Am. Chem. Soc.* **1995**, *117*, 634-644.
- [106]. Nicolaou, K. C.; Yang, Z.; Liu, J. J.; Nantermet, P. G.; Claiborne, C. F.; Renaud, J.; Guy, R. K.; Shibayama, K. *J. Am. Chem. Soc.* **1995**, *117*, 645-652.
- [107]. Nicolaou, K. C.; Ueno, H.; Liu, J. J.; Nantermet, P. G.; Yang, Z.; Renaud, J.; Paulvannan, K.; Chadha, R. *J. Am. Chem. Soc.* **1995**, *117*, 653-659.
- [108]. Ettouati, L.; Ahond, A.; Poupat, C.; Potier, P. *Tetrahedron* **1991**, *47*, 9823-9838.
- [109]. Magee, T. V.; Bornmann, W. G.; Isaacs, R. C. A.; Danishefsky, S. J. *J. Org. Chem.* **1992**, *57*, 3274-3276.